

### Project overview

Project name: Quer-Shooter

Project number: ec4e9f3d8a9e4a7093bcc3736146879016



[i24.ws/?ec4e9f3d8a9e4a7093bcc3736146879016](https://i24.ws/?ec4e9f3d8a9e4a7093bcc3736146879016)

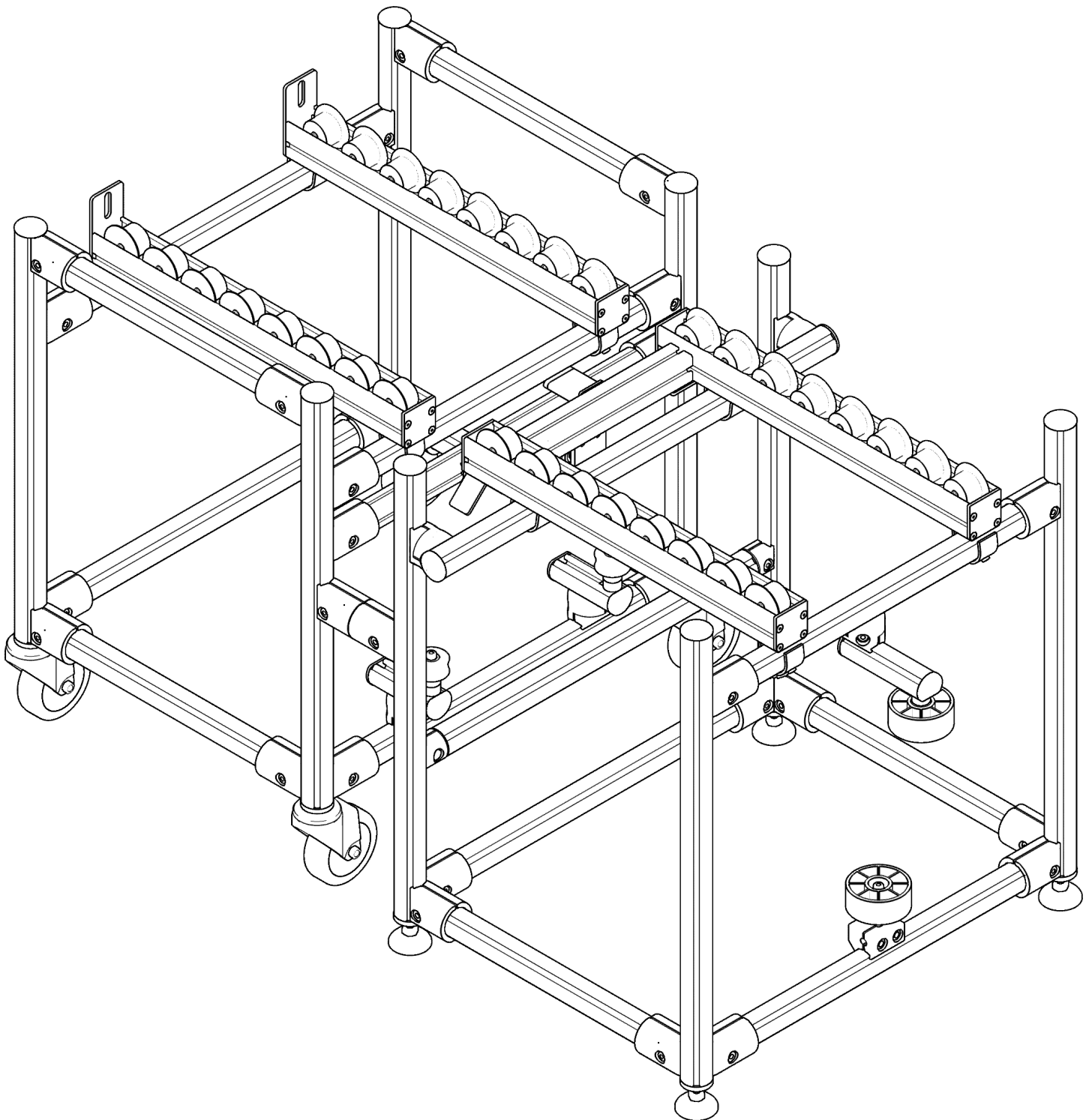

## Parts list

Position	Article designation	Article No.	Quantity
1	Profile 6 30x30, natural, Length: 210mm	0.0.419.01	1
2	Profile 6 D30, natural, Length: 400mm	0.0.616.46	1
3	Profile Tube D30, natural, Length: 50mm	0.0.628.28	1
4	Profile Tube D30, natural, Length: 300mm	0.0.628.28	6
5	Profile Tube D30, natural, Length: 400mm	0.0.628.28	8
6	Profile Tube D30, natural, Length: 455mm	0.0.628.28	4
7	Profile Tube D30, natural, Length: 500mm	0.0.628.28	4
8	Profile Tube D30, natural, Length: 505mm	0.0.628.28	1
9	Profile Tube 8 D30, natural, Length: 75mm	0.0.663.94	2
10	Profile Tube 8 D30, natural, Length: 100mm	0.0.663.94	1
11	Castor D75 swivel	0.0.420.14	4
12	Castor Rail 8 Cap 40x40	0.0.622.29	6
13	Castor Rail 8 Cap 80x40	0.0.622.30	2
14	Cap, Tube D30, grey similar to RAL 7042	0.0.629.78	10
15	Knuckle Foot D40, M8x80, grey similar to RAL 7042	0.0.636.99	4
16	Roller Conveyor 6 40x40 E D30 with Flanged Wheel, Length: 400mm	0.0.658.71	4
17	Release Unit D30 Bar T1	0.0.658.84	1
18	Release Unit D30 Actuator Ramp 120-38	0.0.658.88	1
19	Cap, Profile Tube 8 D30, grey similar to RAL 7042	0.0.666.95	6
20	Roller D39.5-25	0.0.673.55	1
21	Roller Set 8 D30-30 ESD	0.0.681.51	2
22	Spacer Bushing D17/D6-12	0.0.681.67	1
23	Roller D60/D6-25 ESD	0.0.705.94	1
24	Roller Set 8 D60/D6-25 ESD	0.0.712.30	1
25	T-Slot Nut 6 St M6, stainless	0.0.439.75	1
26	Fastener D30	0.0.623.56	30
27	Multiblock D30	0.0.629.96	1
28	Transverse Fastener D30	0.0.637.90	5
29	Hexagon Socket Head Cap Screw DIN 912 M6x16, bright zinc-plated	0.0.655.09	1
30	Fastener D30, internal	0.0.669.52	2
31	Threaded Insert, Profile Tube D30 M8 Al, natural	0.0.675.17	8
32	Bracket 6 30 flat, white aluminium, similar to RAL 9006	0.0.677.74	2
33	Bracket 6 D30 T2	0.0.677.94	8
34	Fastening Set 6 3-5mm with Countersunk Screw M6	0.0.680.94	4
35	Hexagon Socket Head Cap Screw DIN 912 M6x40, bright zinc-plated	8.0.000.82	1
36	Countersunk Screw DIN 7991 M8x25, bright zinc-plated	8.0.006.39	4

Fasteners ( All together )

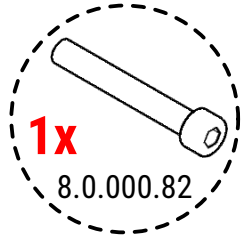
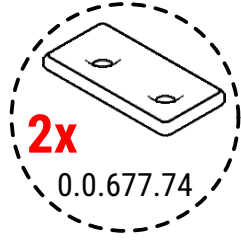
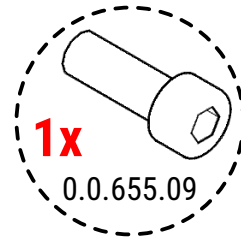
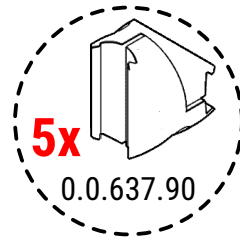
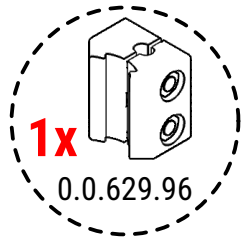
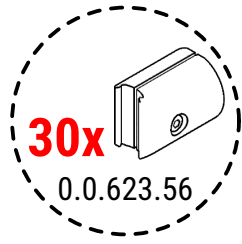
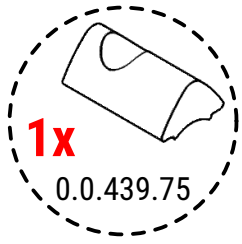

Multiview projection Assembly 1 / 1

